



Machine Tool Inspection and Analyzer Solutions



Understanding the true
meaning of **precision**

Contents

03 Introduction

Linear Axes Measurement

04 Position Inspector

06 Position Analyzer

Linear & Rotary Axes Measurement

08 Rotary Inspector

10 Rotary Analyzer

Spindle Measurement

12 Spindle Inspector

13 Spindle Analyzer

Wireless Probe

14 Wireless Trinity probe



Introduction









Our machine tool inspection and analyzer series offer a range of products to provide peace of mind and control by guaranteeing your machine is within specification. When you require precise measurement, rapid results and tangible improvements. A series of six options provide solutions for measuring the accuracy of the linear axis, rotary axis and spindle. Compensation is available for the linear and rotary axes.

Inspector Series

- **Speed:** Machine inspection to micron accuracy and below in minutes
- **Simplicity:** Automated measurement to ISO standards
- **Assurance:** Digital quality reporting and interactive history
- **Control:** Tolerance setting and optional compensation

Analyzer Series

- **Power:** In-depth measurement and diagnostics
- **Flexibility:** User defined machine analysis
- **Accuracy:** From microns to nm
- **Speed:** Complex measurements executed in minutes

	LINEAR AXIS	LINEAR & ROTARY AXIS	SPINDLE
 Inspector Series	 04	 08	 12
 Analyzer Series	 06	 10	 13

Position Inspector



The Position Inspector measuring system delivers rapid and precise measurement for the positioning accuracy of your machine's linear axes.

What is a Position Inspector linear axes test?

The Position Inspector consists of a cross shaped artefact that is placed on the machine table and a wireless measurement probe that is inserted in the spindle. The artefact consists of 13 precision balls whose position is known with sub-micron accuracy. The cross is aligned with two of the machine's linear axes and the machine is commanded to move the probe to each of the balls in a set sequence. The probe measures the error that occurs in positioning of the probe in X, Y and Z directions, and hence calculates the linear axes errors. The artefact can be pallet mounted and the probe placed in the toolchain.

What are the benefits of a Position Inspector linear axes test?

Laser interferometers are commonly used to calibrate the linear axes of machine tools. Despite that these instruments are well known and used, the required measuring time is problematic for application in industry. What is more, such measurements cannot typically be automated, require an expert, and protection covers have often to be removed to gain access. The Position Inspector is designed to overcome these issues and provide a rapid, automatic method for calibration of machine linear axes. Measurements are made according to international standards (ISO 230). Results are presented in a digital quality report as well as an interactive history function.

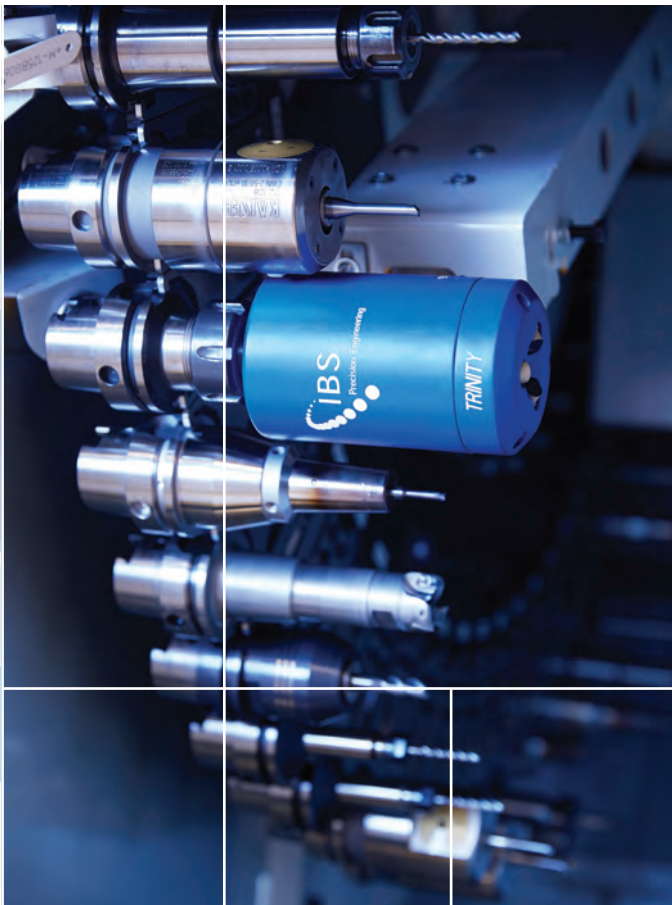



Unique strengths of the Position Inspector:

- Instantaneous qualification of tool positioning accuracy (for end product conformity)
- High performance measurement with 0,2 µm resolution
- Full measurement of X, Y and Z axes within 5 minutes
- Linear axes positioning, straightness, squareness and reversal errors (ISO 230-1, -2), including compensation tables
- Machine specific threshold values determine when the machine is out of tolerance
- Data tracking supports predictive maintenance scheduling
- Automated compensation tables enable corrective action to avoid wasted products
- Suitable for 3, 4 and 5-axis machines

Provided in the Position Inspector kit:

The Position Inspector kit includes a wireless Trinity probe plus battery charger. A traceable cross-shaped artefact is supplied with calibration certificate. The Position Inspector Software App is included. A standard NC program library is available for all major machine configurations and controllers for rapid integration. Requested programs from this library are supplied with the kit. For probe specifications see page 14.



Position Analyzer



When you need in-depth analysis and diagnostics of your machine tool linear axes, the Position Analyzer provides the measurement capability you need, with the flexibility to adapt to the specific needs of your machines.

What is a Position Analyzer linear axes test?

The Position Analyzer consists of a ball beam artefact that is placed on the machine table and a wireless measurement probe that is inserted in the spindle. The artefact contains a line of balls whose position is known with sub-micron accuracy. Alternatively, custom made artefacts can be delivered for specific machine applications. The artefact may be positioned in any orientation within the machine. The machine is commanded to move the probe to each of the balls in a sequence defined by the user. The probe measures the error that occurs in positioning of the probe in X, Y and Z directions, and calculates the linear axes errors according to the test defined.

What are the benefits of a Position Analyzer linear axes test?

The Position Analyzer was designed as a sister product to the Position Inspector, for applications where machine size or layout requires a specially defined measurement artefact. The Position Analyzer offers all the advantages of rapid measurement and sub-micron accuracy, similar to the Position Inspector. However the use of alternative artefacts and orientations allows for unique machine measurements. The system provides a simple but powerful principle to measure the machine's 3D positioning and straightness errors according to ISO 230 plus much more with comprehensive diagnostic capability.

A large probe range enables simple set-up without the need for complex alignment procedures. Artefact measurement is completed in minutes.

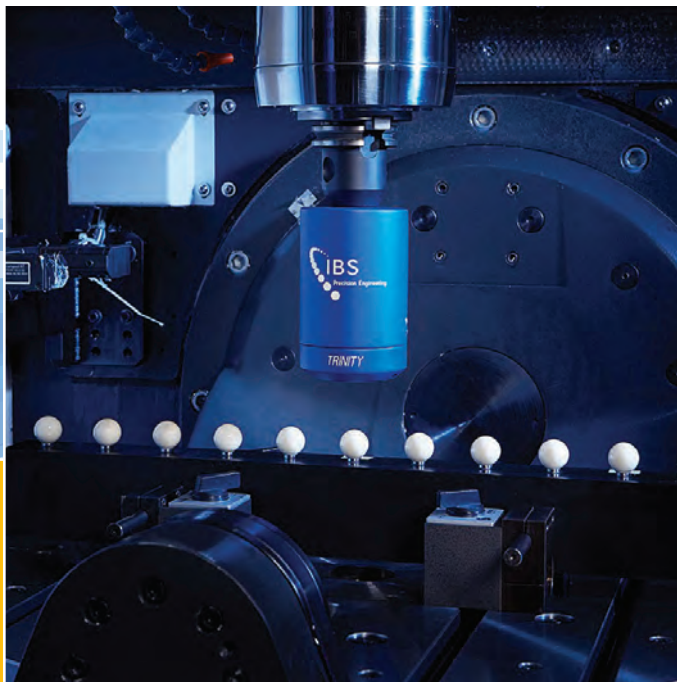



Unique strengths of the Position Analyzer:

- Rapid and comprehensive machine volumetric positioning accuracy determination
- Simultaneous measurement of position and straightness errors
- Customer defined artefacts and measurements
- Easy definition of user defined measurement protocols for in-depth machine characterization, such as reversal error, backlash assessment
- Simple automated set-up delivers accuracy comparable to a laser interferometer
- Measurement according to ISO 230 and 12780 standards
- Complete and portable system

Position Analyzer ball beams

A range of standard ball beams is available for the Position Analyzer. Alternatively artefacts can be made to order. The standard ball beam is constructed from 22 mm diameter precision balls. The number and spacing of the precision balls can be chosen according to the application.

Standard available ball beams

Ball beam	Nominal length	Nr. of balls	Ball distance	Beam material*
MTB-500SC	500 mm	11	50 mm	Silicon Carbide
MTB-1000SC	1000 mm	21	50 mm	Silicon Carbide
MTB-1500SC	1500 mm	16	100 mm	Silicon Carbide

* Silicon carbide (carbon fibre available on request)

Provided in the Position Analyzer kit:

The Position Analyzer kit includes a wireless Trinity probe plus battery charger. A calibrated artefact is supplied with calibration certificate, plus mounting accessories. The probe and artefact are supplied in a travel case. The Position Analyzer Software App is included. For probe specifications see page 14.



Rotary Inspector



Qualifying the performance of 5-axis machines can be complex. The Rotary Inspector measurement system provides a revolutionary method to simplify this process; enabling rapid assessment and correction of the full 5-axis kinematic performance.

What is a Rotary Inspector axes test?

The Rotary Inspector consists of a master ball that is placed on the machine table and a wireless measurement probe inserted in the spindle. The machine is commanded to rotate the first rotary axis whilst two linear axes follow. The probe in the spindle represents the tool path and the master ball the workpiece. The probe measures the relative positioning error in X, Y and Z directions at the Tool Centre Point (TCP). This 3-axis test is repeated for the second axis followed by a full 5-axis test. Rotary axis pivot line and squareness errors are measured plus the 5-axis volumetric and dynamic errors over the full 3D volume of the machine. Automatic compensation is available as an option.

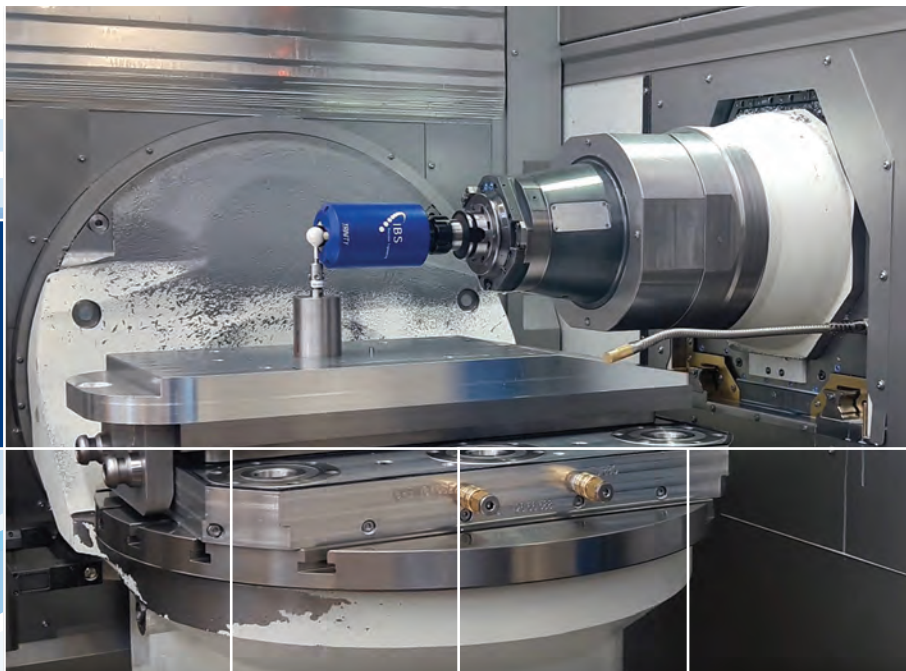



What are the benefits of a Rotary Inspector rotary axes test?

Touch probe measurements are commonly used to correct rotary axis misalignment. However these static measurements do not represent the true dynamic error of the machine. Alternative laser measurements are difficult and slow. The Rotary Inspector measurement is fully automated and completed in under 1 minute. The Rotary Inspector measurement shows the actual tool path, highlighting other sources of error such as controller settings, dynamic instabilities or bearing performance issue. Rapid measurement allows for tracking of error development over time such as thermal distortion or immediate effects of maintenance actions. A digital quality report is created instantaneously including quality figures (KPIs) for machine geometrical error (Q-value) and dynamic error (P-value).

Unique strengths of the Rotary Inspector:

- 5-axis dynamic measurement (according to ISO 10791-6)
- Measurement time < 1min
- Rotary axes pivot line and squareness errors are instantly calculated
- KPIs: Q-value give geometrical error (microns) which leads to product form errors. P-value gives dynamic error (microns) which leads to surface errors.
- Digital quality report
- Status & trend data: machine, group, cell or factory level
- Automated process including tolerance settings per machine
- Optional automatic axes error compensation

Provided in the Rotary Inspector kit:

The Rotary Inspector kit includes a wireless Trinity probe plus battery charger, master ball and mounting accessories plus travel case. The Rotary Inspector Software App is included. A standard NC program library is available for all major machine configurations and controllers. Requested programs are supplied with the kit. For probe specifications see page 14.



Rotary Analyzer



For comprehensive analysis and diagnostics of 5-axis machine tools, the Rotary Analyzer places full capability in your hands.

What is a Rotary Analyzer axes test?

The Rotary Analyzer consists of a master ball that is placed on the machine table and a wireless measurement probe inserted in the spindle. The machine is commanded to complete a user defined 3-, 4- or 5-axis test. Like the Rotary Inspector the path of the probe, representing the Tool Centre Point (TCP), is measured relative to the master ball, representing the workpiece. In this way the errors in the cutting path are directly measured and visualized in X, Y and Z directions. The master ball can be pallet mounted and the probe placed in the toolchain.

What are the benefits of a Rotary Analyzer rotary axes test?

The Rotary Analyzer was designed as a sister product to the Rotary Inspector, for applications where machine specific tests and in-depth analysis are wanted. The Rotary Analyzer offers all the advantages of rapid measurement and sub-micron accuracy of the Rotary Inspector.

The Rotary Analyzer App can be easily programmed to perform a range of user defined tests including ISO standard measurements. Both static and dynamic tests can be performed and a suite of analysis options allows for in-depth characterisation of the machine tool performance. Machine tool developers and professional maintenance providers can quantify multi-axis machine performance in real time. Customised machine acceptance tests can be developed and measurements completed in minutes.

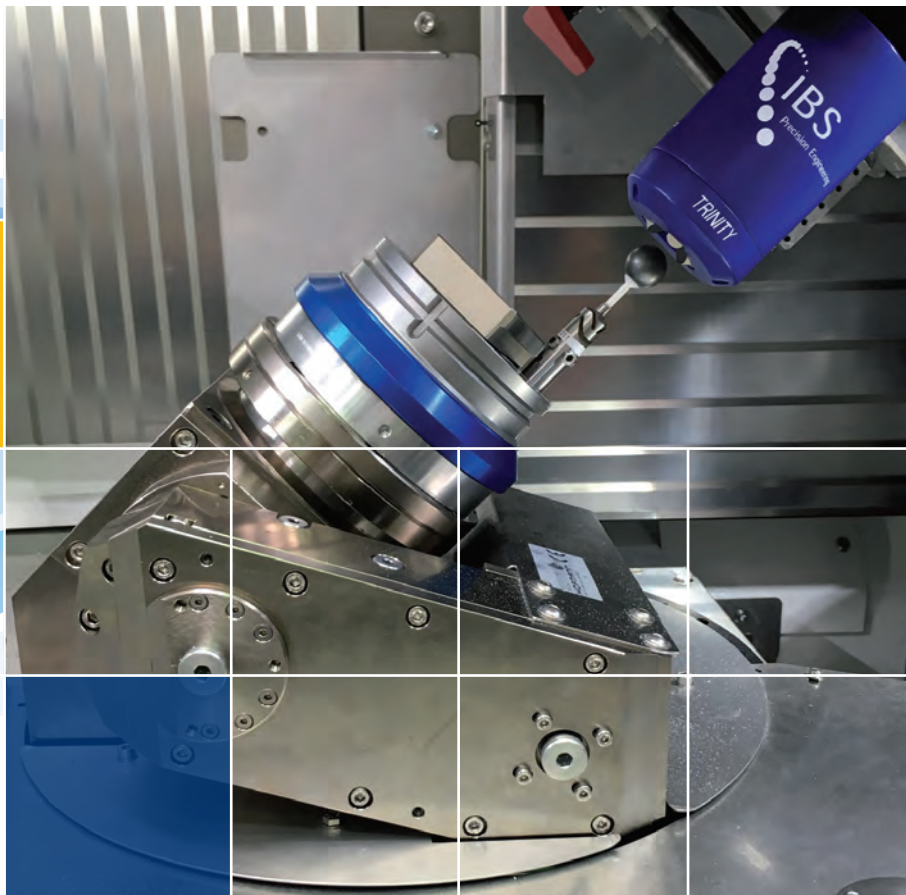



Unique strengths of the Rotary Analyzer:

- Measurement of any multi-axis machine operation in 3D
- Both static and dynamic measurements with sub-micron accuracy (to ISO 10791-6)
- Dynamic analysis including FFT and polar plots
- Data comparison (machine to machine, static versus dynamic, etc)
- Measurement data export options.
- Calibration of rotary table position and squareness, both static and dynamic
- Complete and portable system

Provided in the Rotary Analyzer kit:

The Rotary Analyzer kit includes a wireless Trinity probe plus battery charger, master ball and mounting accessories plus travel case. The Rotary Analyzer Software App is included. For probe specifications see page 14.



Integrated Spindle Inspector



IBS has over 30 years' experience in spindle performance measurement for advanced applications. For spindle developers, the Integrated Spindle Inspector offers accuracy, speed, and an intelligent measuring solution that can be easily integrated into your spindle and control systems.

What is a Spindle Inspector test?

Spindles must turn true in the X, Y and Z directions to make good parts. Rotational or elongation errors in any of these directions can cause bad parts or expensive tool wear and breakage. With this integrated solution, sensors are built into the spindle itself and simultaneously measure machine spindle runout in the X, Y, and Z directions. The sensors are distributed around the spindle, measuring against a rotating ring attached to the spindle. Axial and radial error motions are measured at 15kHz with up to 5 sensors and 65 nm resolution.

What are the benefits of a Spindle Inspector test?

The direct integration of spindle measurement data into a control system enables real-time monitoring of your spindle's performance. The sensors and electronics are designed to have a minimum footprint to save space and fit in the available area. The sensors are unaffected by contaminants

like oil and machine coolant and will withstand pressures up to 5 bar and temperature up to 80°C.

Sub-micron precision means that even the smallest errors can be reliably detected. Each sensor channel has a digital EtherCat output, but can also be configured with RS485 or SPI or an analog output.

Unique strengths of the Spindle Inspector

- Measurement of dynamic spindle performance up to 100,000 rpm
- High performance non-contact measurement at 65 nm resolution at 15 kHz
- Sensors integrated into the spindle or housing withstanding 5 bar and 80°C
- 1 (Z-only), 3 (X,Y,Z) or 5 sensor (X,Y,Z tilt) options
- Swarf, vibration, thermal and bearing effects detected
- Vibrations 2g continuous; 5g max

Spindle Inspector solutions are made to order for spindle developers.

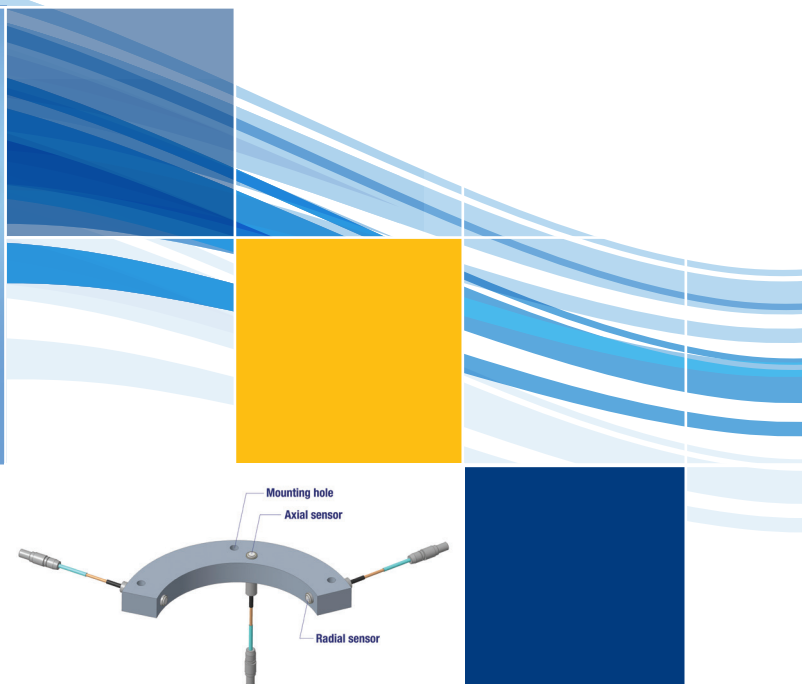
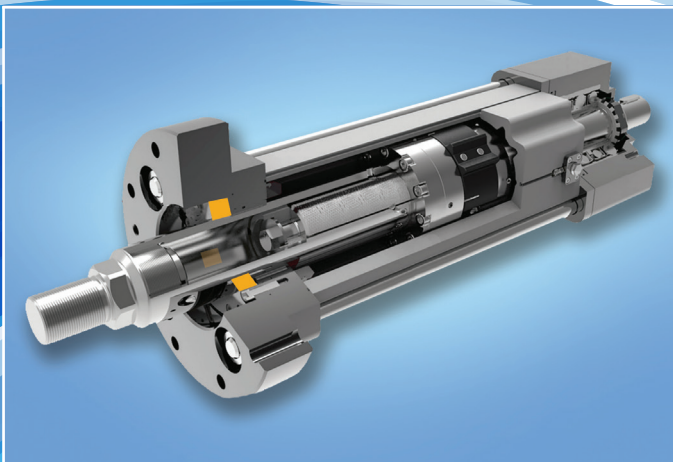

Spindle Analyzer Systems



For in-depth, spindle accuracy and performance assessment at the nanometer level IBS offers two complementary Spindle Analyzer systems:

Spindle Check Analyzer

Spindle Check Analyzer is designed for shop floor use where regular and rapid inspection is required.



Spindle Error Analyzer

For machine tool builders or other expert users we also offer the Spindle Error Analyzer. This offers additional measurement and analysis options for further detailed assessment.



	Spindle Check Analyzer	Spindle Error Analyzer
Measurement capabilities		
Number of axes (channels)	3	Up to 5
Temperature sensors	None	7
Samples per revolution	Automatic (speed dependent)	1-5000
Displayed revolutions	32	1-500
Encoder driven sampling option	No	Yes
Highest available resolution	10nm	<1nm
Tests performed		
Axial	√	√
Radial - fixed sensitive & rotating sensitive	√	√
FFT	√	√
Thermal Drift	√	√
Tilt	-	√
Reversal	-	√
Shift vs RPM	-	√
Portability		
Case size	46 x 33 x 18 cm	81 x 61 x 36 cm
Case weight	8 kg	39kg

Wireless Trinity probe

| Patent protected

The Position and Rotary INSPECTOR and ANALYZER series employ IBS Precision Engineering's patented wireless Trinity probe system. Unlike other systems the Trinity's unique design enables the execution of non-contact X, Y and Z measurements simultaneously with exceptional measurement speed and accuracy.

Measurements are based on master ball(s) mounted on the machine tool. Moving the probe on to the master ball, three highly accurate sensors in the probe head are used to determine its center point position with sub-micron accuracy.

The Trinity probe system consists of:

- Calibrated Trinity probe
- Wireless access point
- Wireless USB receiver
- Travel case
- 4 batteries (3100 mAh) including charger & adapter



Specifications Probe

Measuring range	3.50mm
Resolution	0.25 μm
Sampling rate	2 kHz
Measuring uncertainty	$U1 < 1,0 \mu\text{m}$ (within 1mm range)
Power consumption	> 24 hrs mixed operation
	1,3 W (=17 hrs) when measuring
	0,52 W (=42 hrs) when in sleep mode
Wireless details PSK	2,4 GHz frequency, 802.11b/g/n standard, WPA2 - security
Probe mounting shaft	$\varnothing = 16\text{mm}$
Dimensions	Length: 135mm; Diameter: 80 mm; Weight: 770 grams

Specifications Masterball

Diameter (normal)	22 mm
Length	75 mm



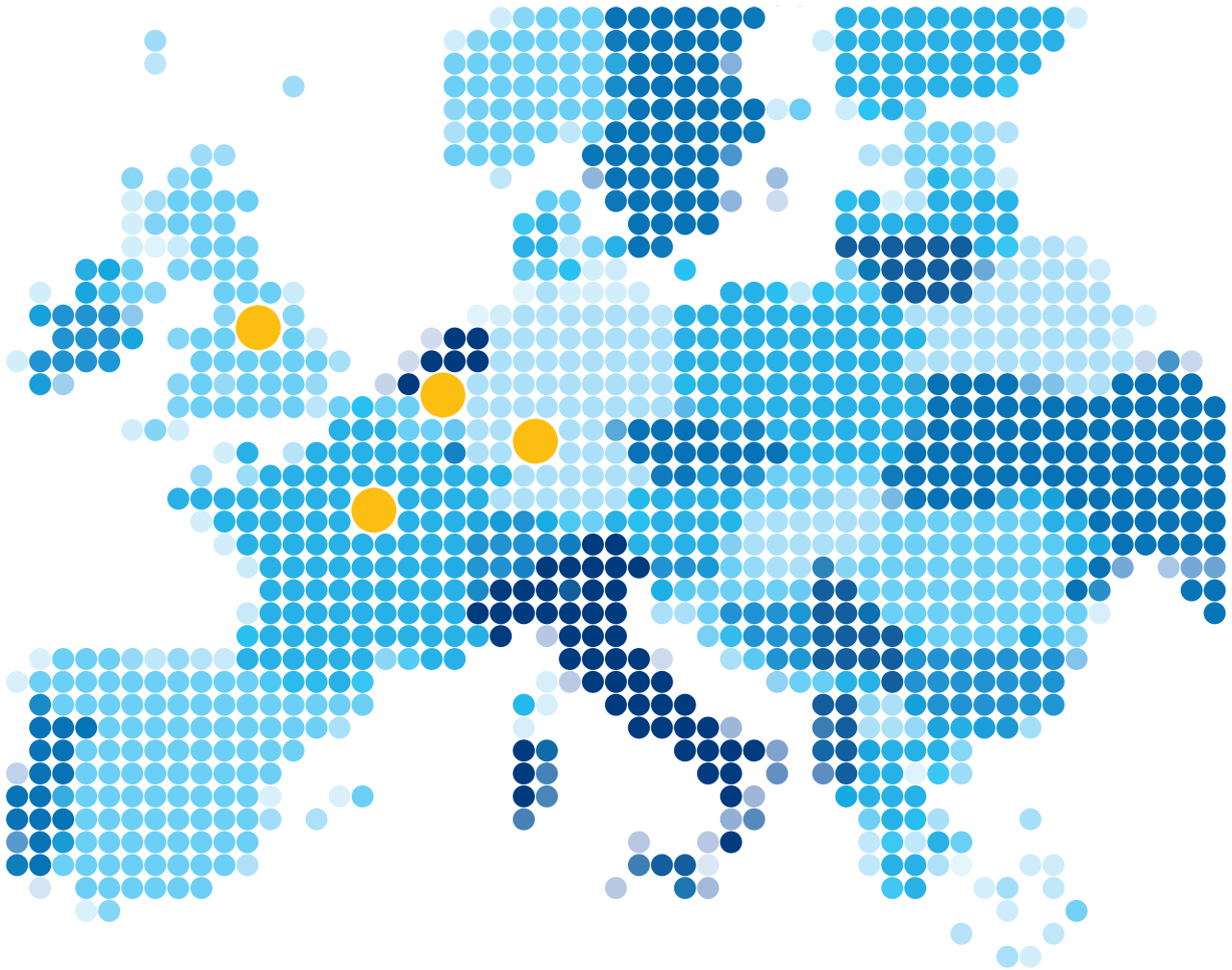

**IBS Precision Engineering BV
(Head Office)**

Esp 201
5633 AD Eindhoven, The Netherlands
Telephone: +31 40 290 1270
E-mail: info@ibspe.com
www.ibspe.com

**IBS Precision Engineering
Deutschland GmbH**

Leitzstraße 45
70469 Stuttgart, Germany
Telephone: +49 711 490 66 132 (Nord)
Telephone: +49 711 490 66 133 (Süd)
E-mail: info@ibspe.de
www.ibspe.de

IBS Precision Engineering sarl

10 rue Michel Servet
59000 LILLE Cedex, France
Telephone: +33 3 66 21 25 24
E-mail: info@ibspe.com
www.ibspe.com

IBS Precision Engineering Ltd

Blythe Gate, Blythe Valley Park
Solihull B90 8AH, United Kingdom
Telephone: +44 (0) 7464 210568
E-mail: info@ibspe.com
www.ibspe.com